

IMPORTANT SAFETY RULES

Please read, understand, and follow all instructions carefully before installing and using this product. Keep for future reference.

PureSpa™ Greywood Deluxe™ SB-HWF20

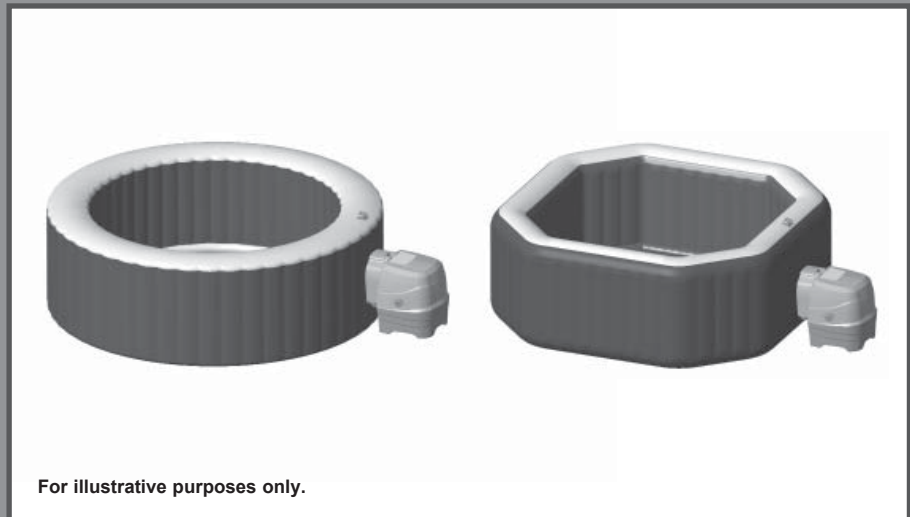

Do not forget to try these other fine Intex products: pools, pool accessories, in-home toys, airbeds and boats available at fine retailers or visit our website.

Due to a policy of continuous product improvement, Intex reserves the right to change specifications and appearance, which may result in updates to the instruction manual without notice.

INTEX®

©2023 Intex Marketing Ltd. - Intex Development Co. Ltd. - Intex Recreation Corp. All rights reserved/Tous droits réservés/Todos los derechos reservados/Alle Rechte vorbehalten. Printed in China/Imprimé en Chine/Impreso en China/ Gedruckt in China.

®™ Trademarks used in some countries of the world under license from/®™ Marques utilisées dans certains pays sous licence de/Marcas registradas utilizadas en algunos países del mundo bajo licencia de/Warenzeichen verwendet in einigen Ländern der Welt in Lizenz von/Intex Marketing Ltd. to/à/a/an Intex Development Co. Ltd., Hong Kong & Intex Recreation Corp., P.O. Box 1440, Long Beach, CA 90801 • Distributed in the European Union by/Distribué dans l'Union Européenne par/Distribuido en la unión Europea por/Vertrieb in der Europäischen Union durch/Intex Trading B.V., Ettenseweg 46, 4706 PB Roosendaal – The Netherlands • Distributed in the UK by Unitex Service (UK) Limited, 21 Holborn Viaduct, London EC1A 2DY, UK.
www.intexcorp.com

TABLE OF CONTENTS

Warning.....	3-6
Parts.....	7-8
Set-up.....	9-14
Operation.....	15-20
Minimize Heat Loss and Energy Consumption Advice.....	20
LED Code Chart.....	21
Maintenance and Chemicals.....	22-26
Storage.....	26
Troubleshooting.....	27-30
Filter pump motor disassembly.....	31
Warranty.....	32

IMPORTANT SAFETY RULES

When installing and using this electrical equipment, basic safety precautions should always be followed, including the following.

READ AND FOLLOW ALL INSTRUCTIONS

⚠ DANGER

- Risk of Accidental Drowning (especially children under 5 years). Caution shall be exercised to prevent unauthorized access to spa by children. This can be reached by adult supervisor securing the means of access or installing a safety protection device to the spa. To avoid accidents during spa use, ensure that children are kept under constant supervision.
- Risk of drowning. Inspect the spa cover regularly for leaks, premature wear and tear, damage, or signs of deterioration. Never use a worn or damaged cover: it will not provide the level of protection required to prevent unsupervised access to the spa by a child.
- Risk of injury. The suction fittings in this spa are sized to match the specific water flow created by the pump. Should the need arise to replace the suction fittings or the pump, be sure that the flow rates are compatible. Never operate spa if the suction fittings are broken or missing. Never replace a suction fitting with one rated less than the flow rate marked on the original suction fitting.
- Risk of injury. Replace damaged cord immediately. Do not bury cord. Never use an extension cord.
- Risk of Electric Shock. Do not permit any electric appliance, such as a light, telephone, radio, or television, within 3.5 m (11.5 feet) of a spa or hot tub.
- Risk of Electric Shock. Do not use and unplug the spa when it is raining, thundering or lightning.

⚠ WARNING

- The spa electrical appliance should be supplied through a residual current device (RCD) having a rated residual operating current not exceeding 30 mA.
- The spa electrical appliance comprises a portable residual current device (PRCD) having a rated residual operating current not exceeding 10 mA. If a leakage current of more than 10 mA is detected, the PRCD will operate and cut-off the power supply, in such case, unplug and stop using the spa at once. You must contact the local service center for assistance and/or repair of the product.
- Parts containing live parts, except parts supplied with safety extra-low voltage not exceeding 12V, must be inaccessible to a person in the spa.
- Electrical installation shall fulfill the requirements of local national standards.
- Parts incorporating electrical components, except remote control devices, must be located or fixed so that they cannot fall into the spa.
- To reduce the risk of injury, do not permit children to use this product unless they are closely supervised at all times.
- Children should not use spas or hot tubs without adult supervision.
- To reduce the risk of child drowning, supervise children at all times. Attach and lock spa cover after each use.
- To reduce the risk of injury/illness:
 - a) The water in a spa should never exceed 40°C (104°F). Water temperatures between 38°C (100°F) and 40°C (104°F) are considered safe for a healthy adult. Lower water temperatures are recommended for young children and when spa use exceeds 10 minutes. It is recommended to seek medical advice before use.
 - b) Since excessive water temperatures have a high potential for causing fetal damage during the early months of pregnancy, pregnant or possibly pregnant women should limit spa water temperature and duration of use and should also seek medical advice.

⚠ WARNING

- c) The user should check the water temperature before entering the spa.
- d) The use of alcohol, drugs, or medication before or during spa use may lead to unconsciousness with the possibility of drowning.
- e) Persons with any medical condition should seek medical advice before using a spa.
- f) Persons using medication and/or having an adverse medical history should seek medical advice before using a spa since some medication may induce drowsiness while other medication may affect heart rate, blood pressure, and circulation.
- g) Avoid putting the head underwater and swallowing spa water.
 - People with infectious diseases should not use a spa or hot tub.
 - To avoid injury exercise care when entering or existing the spa or hot tub.
 - Pregnant and possible pregnant women should consult a physician before using a spa or hot tub.
 - Water temperature in excess of 38°C degree may be injurious to your health.
 - Do not use a spa or hot tub immediately following strenuous exercise.
 - Prolonged immersion in a spa or hot tub may be injurious to your health.
 - When pregnant, soaking in hot water for long periods can harm your fetus. Measure the water temperature before entering. Do not enter spa if water is hotter than 38°C (100°F). Do not stay in spa for longer than 10 minutes.
 - Spa heat in conjunction with alcohol, drugs, or medication can cause unconsciousness.
 - Exit immediately if uncomfortable, dizzy, or sleepy. Spa heat can cause hyperthermia and unconsciousness.
 - The causes, symptoms, and effects of hyperthermia may be described as follows: Hyperthermia occurs when the internal temperature of the body reaches a level several degrees above the normal body temperature of 37°C (98.6°F). The symptoms of hyperthermia include an increase in the internal temperature of the body, dizziness, lethargy, drowsiness, and fainting. The effects of hyperthermia include failure to perceive heat; failure to recognize the need to exit spa or hot tub; unawareness of impending hazard; fetal damage in pregnant women; physical inability to exit the spa or hot tub; and unconsciousness resulting in the danger of drowning.
 - The use of alcohol, drugs, or medication can greatly increase the risk of fatal hyperthermia in hot tubs and spas.
 - Always add chemicals to water, never add water to chemicals. Adding water to chemicals may cause strong fumes or violent reactions and hazardous chemical spray.
 - Never jump or dive into a spa or any shallow body of water.
 - Assembly and disassembly by adults only.
 - This appliance can be used by children aged from 8 years and above and persons with reduced physical, sensory or mental capabilities or lack of experience and knowledge if they have been given supervision or instruction concerning use of the appliance in a safe way and understand the hazards involved. Children shall not play with the appliance. Cleaning and user maintenance shall not be made by children without supervision.
 - No part of the electrical appliance is to be located above the bath during use.
 - Keep the plug of this product more than 4m away from the spa and at a height of 1.2m at least.
 - Always unplug this product from the electrical outlet before removing, cleaning, servicing or making any adjustment to the product, and on raining days.
 - Do not bury the electrical cord. Locate the cord where it will not be damaged by lawn mowers, hedge trimmers and other equipment.

⚠ WARNING

- If the supply cord is damaged, it must be replaced by the manufacturer, its service agent or similarly qualified persons in order to avoid a hazard. Use only identical replacement parts when servicing.
- **Always keep plug dry, plug in with wet plug is definitely forbidden!**
- The plug of SPA must be directly connected only to a earthed socket-outlet from a fixed electrical installation.
- To reduce the risk of electric shock and fire, do not use extension cords, timers, plug adaptors or converter plugs to connect unit to electrical supply; provide a properly located outlet.
- Do not attempt to plug in or unplug this product while standing in water or when your hands are wet.
- Do not leave the spa empty for extended period of time. Do not expose the spa to direct sunlight for extended period of time.
- When the appliance is not in use for long period of time, such as in the winter, the spa set should be disassembled and stored indoor.
- Do not allow the water in the spa to freeze. Do not turn on the spa when the water is frozen.
- Do not use the spa if damaged in delivery and/or malfunctioning in any fashion. Contact the Intex service center for further direction.
- Never use the spa alone or allow others to use the spa alone.
- Never pour water with a temperature higher than 40°C (104°F) into the spa directly.
- Keep all pets away from spa to avoid any damage.
- Do not add bath oil or bath salt to the spa water.
- The spa must be setup on a level, flat and smooth surface that is capable of supporting the maximum load of the filled spa with four adult occupants: weight 1136 kg (2500 lbs); six adults: 1592 kg (3500 lbs).
- Provide adequate drainage system around the spa to deal with overflow water and splashes.
- Use accessories exclusively provided by the spa manufacturer for safety reasons.
- Not for public/commercial use and/or domestic renting dwelling settings.
- All the information pertaining to the installation, cleaning and maintenance please refer to below paragraphs of the manual.
- Never place any metallic objects on the surface of the control base charging dock.

Carefully read, understand, and follow all information in this user manual before installing and using the spa. These warnings, instructions, and safety guidelines address some common risks of water recreation, but they cannot cover all risks and dangers in all cases. Always use caution, common sense, and good judgment when enjoying any water activity. Retain this information for future use.

Non swimmers safety

- Continuous, active, and vigilant supervision of weak swimmers and non-swimmers especially in exercise spas, by a competent adult is required at all times (remembering that children under five are at the highest risk of drowning).
- Designate a competent adult to supervise the spa each time it is being used.
- When the spa is not in use, or unsupervised, remove all toys from the spa and its surrounding area to avoid attracting children to the spa.

Safety devices

- A safety cover or other safety protection device shall be used, or all doors and windows (where applicable) shall be secured to prevent unauthorized access to the spa.

⚠ WARNING

- Barriers, covers, alarms, or similar safety devices are helpful aids, but they are not substitutes for continuous and competent adult supervision.

Safety equipment

- Keep a working phone and a list of emergency phone numbers near the spa.

Safe use of the spa

- Encourage all users especially children to learn how to swim.
- Learn Basic Life Support (Cardiopulmonary Resuscitation - CPR) and refresh this knowledge regularly. This can make a life-saving difference in the event of an emergency.
- Instruct all spa users, including children, what to do in case of an emergency.
- Never dive into any shallow body of water. This can lead to serious injury or death.
- Do not use the spa when using alcohol or medication that may impair your ability to safely use the spa.
- When covers are used, remove them completely from the water surface before entering the spa.
- Protect spa occupants from water related illnesses by advising them to keep water treated and practicing good hygiene. Consult the water treatment guidelines in the user's manual.
- Store chemicals out of the reach of children.
- Attached the safety signage provided on the spa or within 2 m of the spa in a prominent visible position.
- This device contains batteries which cannot be replaced.

⚠ WARNING

- This product is provided with a RCD located at the end of the power cord. The RCD must be tested before each use. Do not use the spa if the RCD does not function properly. Disconnect the power cord until the fault has been identified and corrected. Contact a qualified electrician to correct the fault. Do not bypass the RCD. There are no serviceable parts inside the RCD. Opening the RCD will void the warranty.

1. Plug the unit into a grounded electrical outlet.
2. Press the **RESET** button on the RCD.
3. Turn on the spa electrical equipment.
4. Press the **TEST** button on the RCD. The RCD indicator should turn off and the electrical equipment should shut off. If the RCD indicator does not turn off, and the electrical equipment does not shut off, the RCD is faulty. Do not use the spa. Contact a qualified electrician to correct the fault.
5. Press the **RESET** button on the RCD. The indicator on the RCD should turn on. If the RCD indicator does not turn on, the RCD is faulty. Do not use the spa. Contact a qualified electrician immediately to correct the fault.

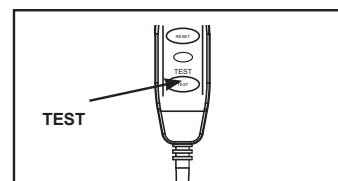
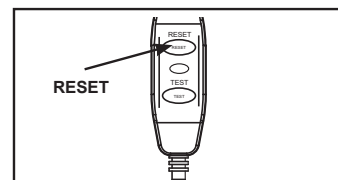

⚠ CAUTION

- In order to avoid a hazard due to inadvertent resetting of the thermal cut-out, this appliance must not be supplied through an external switching device, such as a timer, or connected to a circuit that is regularly switched on and off by the utility.
- Maintain water chemistry in accordance with manufacturer's instructions.

PARTS

Before assembling your product, please take a few minutes to check the contents and become familiar with all the parts.

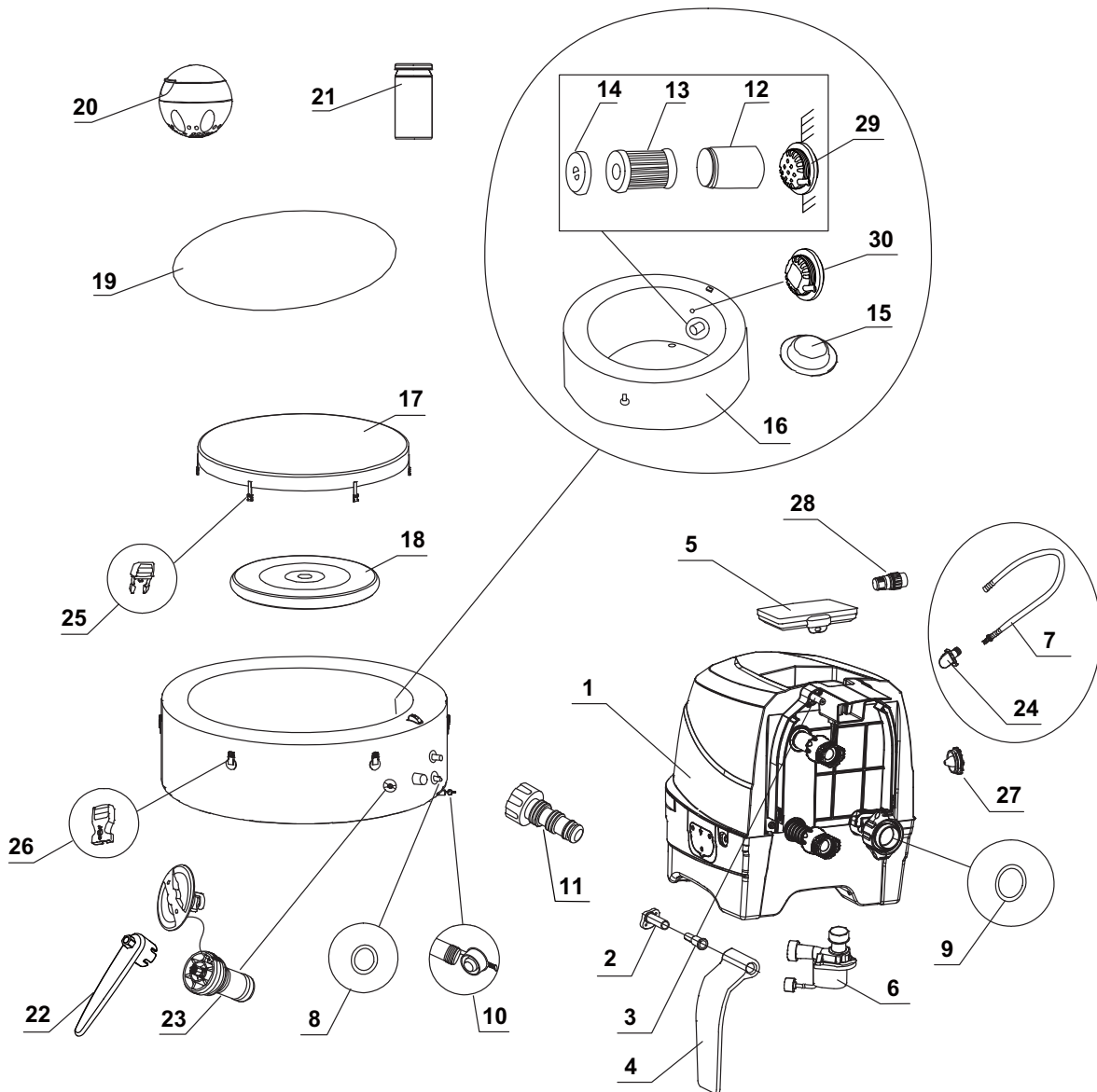

NOTE: Drawings for illustration purpose only. Actual product may vary. Not to scale.

PARTS (continued)

Before assembling your product, please take a few minutes to check the contents
and become familiar with all the parts.

REF. NO.	DESCRIPTION	ROUND			OCTAGON		
		QTY.	PART NO.		QTY.	PART NO.	
			4 ADULTS	6 ADULTS		4 ADULTS	6 ADULTS
1	CONTROL BASE	1	13032	13032	1	13032	13032
2	SIDE COVER HINGE BASE	2	12771D	12771D	2	12771D	12771D
3	SIDE COVER HINGE FIXER	2	12772D	12772D	2	12772D	12772D
4	CONTROL BASE SIDE COVER	2	12770D	12770D	2	12770D	12770D
5	CONTROL PANEL	1	12994	12994	1	12994	12994
6	SPA FILTER MOTOR	1	12778	12778	1	12778	12778
7	SPA/COVER INFLATION HOSE	1	11830	11830	1	11830	11830
8	SPA CONTROL INLET/OUTLET O-RING	2	11699	11699	2	11699	11699
9	SPA CONTROL AIR INLET O-RING	1	11687	11687	1	11687	11687
10	SPA DRAIN PLUG	1	13076	13076	1	13076	13076
11	SPA DRAIN VALVE ADAPTOR	1	13036	13036	1	13036	13036
12	FILTER CARTRIDGE HOUSING	1	11798	11798	1	11798	11798
13	FILTER CARTRIDGE	2	11692	11692	2	11692	11692
14	FILTER CARTRIDGE HOUSING LID	1	11797	11797	1	11797	11797
15	INLET/OUTLET PLUG	3	11739	11739	3	11739	11739
16	SPA TUB	1	10068	12842	1	11880W	12302W
17	SPA COVER	1	11841W	12107W	1	11878W	12303W
18	SPA COVER INFLATABLE BLADDER (PRE-INSTALLED IN SPA COVER)	1	11689	12108	1	11884	12114
19	GROUND CLOTH	1	11717	12109	1	11933	12110
20	CHEMICAL DISPENSER	1	12735	12735	1	12735	12735
21	TEST STRIPS	1	11855	11855	1	11855	11855
22	WRENCH	1	11742A	11742A	1	11742A	11742A
23	AIR PRESSURE RELEASE VALVE CORE	1	12589A	12589A	1	12589A	12589A
24	HOSE ADAPTOR (PRE -INSTALLED WITH #7)	1	12773	12773	1	12773	12773
25	MALE BUCKLE	6	11994	11994	8	11994	11994
26	FEMALE BUCKLE	6	11993	11993	8	11993	11993
27	DEFLATION OUTLET CAP	1	12775D	12775D	1	12775D	12775D
28	DEFLATION HOSE ADAPTOR	1	12774	12774	1	12774	12774
29	OUTLET SUCTION FITTING	1	11695	11695	1	11695	11695
30	INLET SUCTION FITTING	1	12702	12702	1	12702	12702

When ordering parts, be sure to quote the model number and part numbers.

PRODUCT SPECIFICATIONS

Voltage / Frequency / Phase	220 - 240 V / 50 Hz / 1 PH	
Maximum seating capacity:	4 adults	6 adults
Water capacity:	210 gal (795 L)	290 gal (1098 L)
Inner/outer size:	Round: 57/77 in (145/196 cm) Octagon: 51/71 in (130/180 cm)	Round: 65/85 in (165/216 cm) Octagon: 63/83 in (160/211 cm)
Height:	28 in (71 cm)	
Bubble air blower:	800 Watts	
Filter pump flow rate:	460 gal/hr (1,741 L/hr)	
Heater power:	2,200 Watts	
Temperature range:	10°C – 40°C (50°F – 104°F)	
Temperature rise:	1.5-2.5°C/hr (3°F – 4.5°F/hr)	1-2°C/hr (2°F – 3.5°F/hr)
Number of Bubble Jets:	140	170
Spa tub recommended working air pressure:	0.083 bar (1.2 psi)	

RF frequency band: 2408~2476MHz

Transmitter power: 10dBm

Wifi frequency band: 2412~2484MHz

Maximum transmitter power: 100mW

Radio frequency radiation exposure Information:

This equipment complies with the radiation exposure limits set forth for an uncontrolled environment. This equipment should be installed and operated with minimum distance of 20 cm (7.9") between the radiator and your body. This transmitter must not be co-located or operating in conjunction with any other antenna or transmitter. Inflatable, portable aboveground cord-connected spa with pump, heater, blower, built-in hard water treatment and control panel.

Note: the spa equipment features a complete grounding system that is also in contact with the spa water. It is possible that a person may build up static electricity that discharges when touching the water. Regardless, any electric shock experienced should be investigated by a qualified electrician prior to use of the spa. Unplug the spa until the cause is determined and any corrective action completed.

Hereby, Intex Development Company Limited, declares that this SB-HWF20 is in compliance with the essential requirements and other relevant provisions of Directive 2014/53/EU.

⚠ WARNING

Risk of fire: This product draws a minimum of 13 AMPS. Most household circuits are 13 to 16 AMPS. If the circuit breaker trips, please check that no other appliances or other large loads are on the same circuit as the spa. Never use an extension cord. Unfold the line cord prior to use. Never place the plug on combustible materials.

SET UP

Site preparation and requirements

- The spa can be installed indoor or outdoor. For household use only.
- Make sure the area is water resistant, level, flat and free of sharp objects under or around the spa.
- Provide a properly located grounded electrical outlet with a protection grade of IPX4 or higher to connect the spa and allow easy access for periodic testing of the cord mounted RCD.
- Make sure there is enough clearance around the spa for full access to the spa equipment for maintenance and/or service.
- The area shall facilitate draining purposes during long term spa storage. Check local and national regulations regarding spa water disposal requirements.
- To reduce noise disturbance, do not install the spa in the immediate vicinity of vertical walls.
- The area shall be within reach of fresh water supply in compliance with local water regulations, and whose parameters shall be adjusted according to the spa water chemistry and balance section of the manual before first use of the spa.
- Check your local laws and regulations regarding indoor and/or outdoor spa installation.

NOTE: Before setting up and filling the spa with water, make sure the area where the spa will be installed is within your WiFi router coverage range. The area shall be free from metallic walls/mesh and other objects that may interfere with or reduce the WiFi signal.

SET UP (continued)

Additional requirements for indoor installation

- Make sure the floor can support the full weight of the filled spa with the maximum number of occupants. Check with a qualified contractor or a structural engineer to verify this requirement.
- Make sure the floor is water resistant and non-slip surface. Do not install the spa on carpet or other materials that will be damaged by moisture, condensation.
- Do not install the spa indoors on a second floor above finished living space due to the possibility of water and humidity damage.
- Humidity is a natural side effect of indoor spa installation. The room shall be properly ventilated to allow moisture to escape. Install a ventilating system to prevent excess condensation, moisture in the room.
- Have consideration when removing the spa from the chamber/building without destroying part of the built structure. Where non-porous duckboard type flooring is used, make sure it is equipped with a drainage system underneath to allow cleaning and easier removal. When spa is located indoors, watch out for areas that have high water tables as they are prone to flooding.

Additional requirements for outdoor installation

- Spa owners may need to comply with local or states laws relating to childproof fencing, safety barriers, lighting, and other safety requirements. Contact your local building code enforcement office for further details.
- Make sure the surface is level, flat, smooth and strong enough to support the full weight of the filled spa.
- Do not setup the spa on grass or dirt, as this increases the amount of debris entering the spa, and damage the spa floor.
- **Do not expose the spa to direct sunlight for extended period of time. Provide protection from the sun such as sunshade, tent, awning or gazebo.**
- It is possible to install and leave the spa outside at a temperature not lower than 4°C (39°F) provided the water temperature inside the spa is higher than 4°C (39°F) and the water inside the circulation system, pump, pipe are not frozen. Put a "temp barrier mat" between the spa floor and the ground to prevent heat loss from the bottom of the spa and to provide better heat retention. Do not use the spa if the ambient or water temperature is 4°C (39°F) or lower.
- Pay attention to local environmental conditions, such as ground water and risk of frost when install the spa. Professional installer shall have a discussion of these conditions with the client.

Setup the spa with at least 2 persons.

1. Move the entire package to the selected site. Do not drag the spa tub across the ground as this can cause damage and leakage.
Open the carton carefully as this carton can be used to store the spa during long term storage or when not in use.
2. Lay out all the parts on the ground and make sure all the parts are accounted for. For missing or damaged parts contact the appropriate Intex Service Center listed in the separate "Authorized service Centers" sheet.

Spa Control Panel Charging and Installation

1. Make sure the back of the control panel (5) and the control base charging dock surface are clean and dry.
2. Make sure the control base is plugged in and the RCD tested. Place the control panel (5) on the control base charging dock to charge the built-in battery (see drawing 1). See "Spa Control Panel" operation section for more details.
3. It takes approximately 3 hours to fully charge the control panel battery. Once the battery is fully charged, you may place the control panel on top of the spa tub wall (see drawing 2.1). To remove the control panel from the spa tub, lift the latch while pulling the control panel away from the support stand (see drawing 2.2).

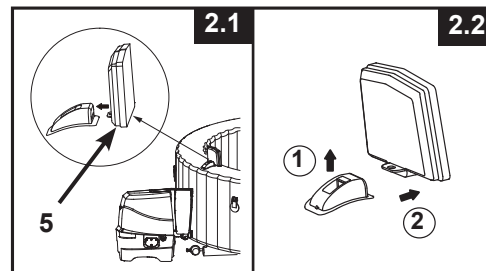
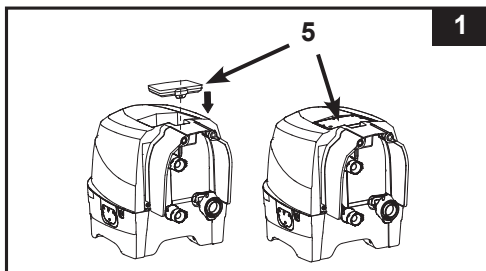

SET UP (continued)

Optional equipotential bonding system

Depending on local building codes and regulations, have a qualified electrician to connect the spa equipotential terminal with a conductor (wire) having a nominal cross-sectional area of 2.5 mm² to 6mm² to the household equipotential terminal. (Wire not included)

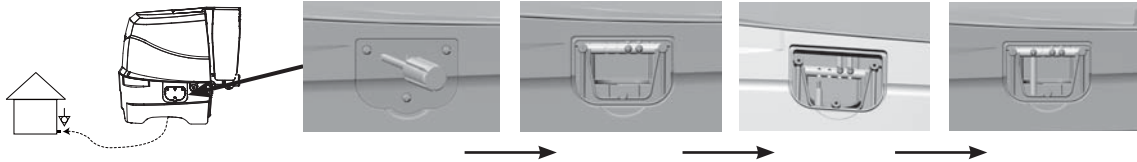

Inflation

Inflate the Spa Tub Wall

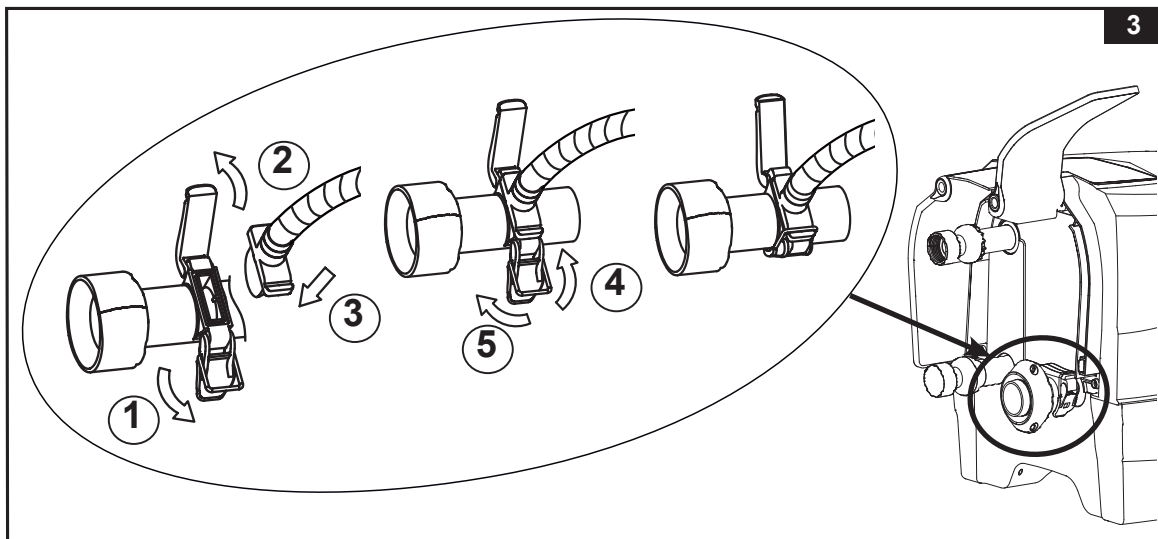

1. Take out the ground cloth (19) and spread it over the cleared area. Then spread out the spa liner over the ground cloth and point the drain valve towards a suitable draining area.
NOTE: Spread the ground cloth with the bubbles facing down over the cleared area where you intend to setup your spa.
2. Flip up the control base side cover (4) to reveal the air blower inflation outlet. Pull out the latch to open the cover, insert the hose adaptor (24) with hose and reattach the latch to the hose adaptor to secure it in place (see drawing 3).

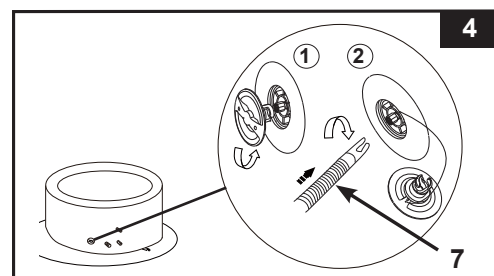

3. Unscrew the air valve cap on the spa tub to reveal the stem in the up position for inflation. Insert the other end of the inflation hose (7) into the valve and turn to the right to lock it in position (see drawing 4).



SET UP (continued)

- Press the  button to turn on the control panel. Press the  button to inflate the spa tub wall for 8 to 10 minutes until it is firm to the touch but not hard (see drawings 5 & 6).
IMPORTANT: Do not over inflate or use high pressure air compressor to inflate.
- Press the  button again to turn it off.

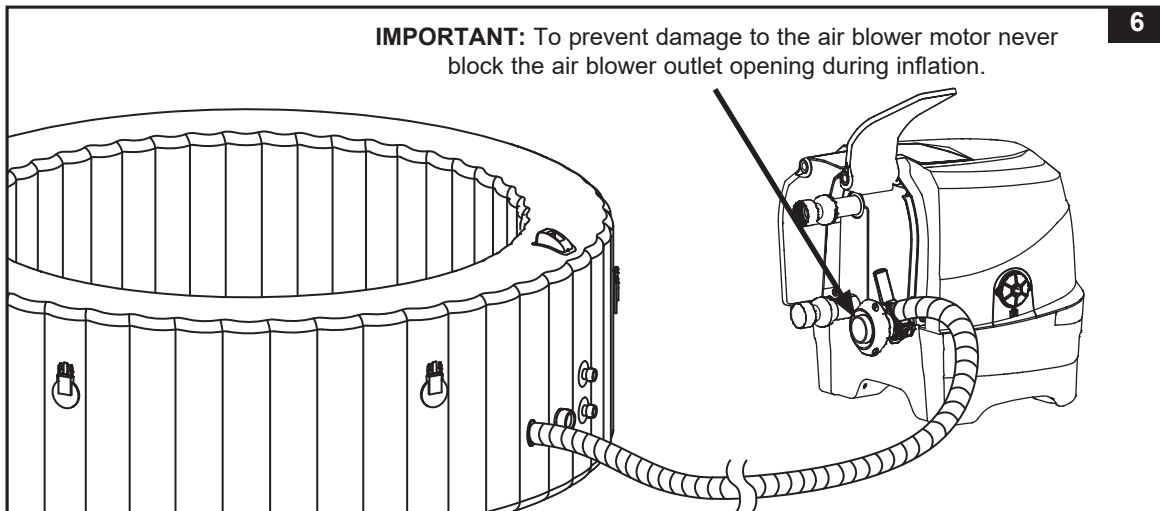
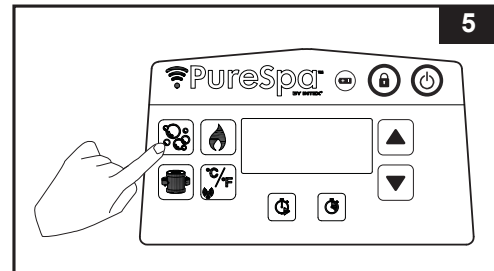

- Replace the air valve cap back. The cap is designed to be screwed on and off. Never exert force as this could cause the complete internal inflation system of the valve to come loose. See "Spa Tub Air Valve Fastening" for valve maintenance.
NOTE: If there is a need to replace the spa tub air pressure release valve core (23) due to wear and tear, use the included wrench (22) to unscrew the core from the valve base. Insert the replacement core and tighten with the wrench. Make sure the core is securely tightened (see drawing 7).

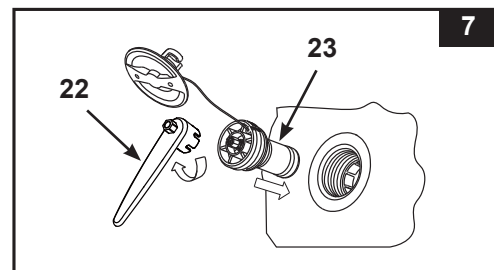

Inflate the Spa Cover Air Bladder

- Open the inflation valve and insert the inflation hose (7) into the valve; press  to inflate until it is firm to the touch but not hard (see drawing 8).
- Disconnect the inflation hose (7) from the air blower inflation outlet and the valve.
- Replace the control base inflation latch back; close and recess the inflation valve.

NOTE: If there is a need to add some air to the spa tub wall or spa cover air bladder after they have been setup, refer to above "Inflate the Spa Tub Wall" and "Inflate the Spa Cover Air Bladder" sections. The cover air bladder is preinstalled inside the spa cover. If it needs to be reinstalled, place the uninflated air bladder inside the spa cover lip before inflating the bladder.

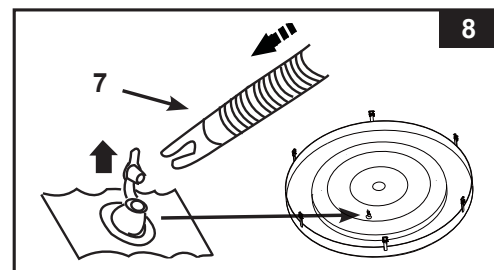

SET UP (continued)

Deflation

For Spa Tub Wall:

1. Unscrew the cap to reveal the stem, push the stem in and turn 90 degree right to secure it in the down position (**see drawing 9**).
 2. Once the deflation is completed, push the stem in and turn 90 degree left to return it to the inflation position.
 3. Replace the cap back.
- NOTE:** To deflate the spa tub for storage, see "STORAGE" section.

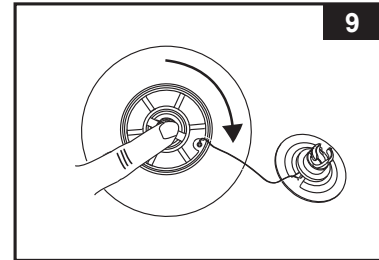

For Cover Air Bladder:

1. Pull valve cap out and squeeze the valve at its base until deflated.
2. Close and recess the valve back.



IMPORTANT

The spa tub inflation/deflation valve incorporates an "air pressure release" function that automatically releases excess air when the spa tub internal pressure is between 1.5 - 2.5 psi (0.103 - 0.172 bar).

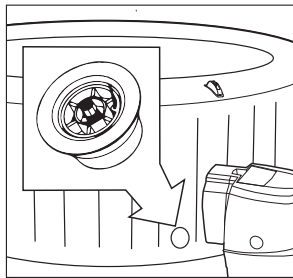

Air pressure release valve.

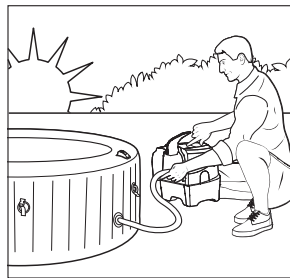

Inflation of spa in the morning.

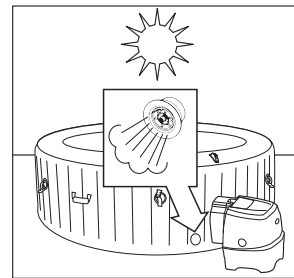

Air expands in the midday heat. Air pressure release valve kicks in and releases excess air.

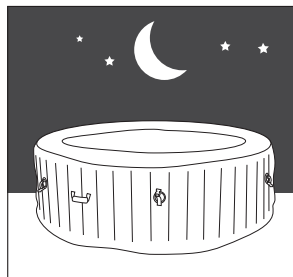

Colder temperatures at night cause the spa to seem less inflated.

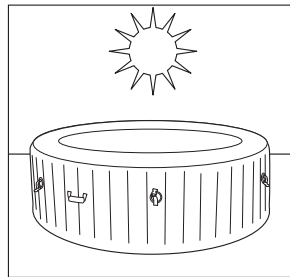

Air expands in the midday heat and correct air pressure is restored.

SET UP (continued)

Spa Control Unit Installation

1. Connect the spa control unit to the spa tub (see drawing 10). Hand-tighten the connectors securely. Do not use tools to tighten.
NOTE: Never attach external accessories not supplied with the kit to the spa tub or control base unit, as this will void the warranty.
2. Replace the control base side covers (4) (see drawing 11).

CAUTION: Do not sit, lean, cover or place any objects over the spa control unit.

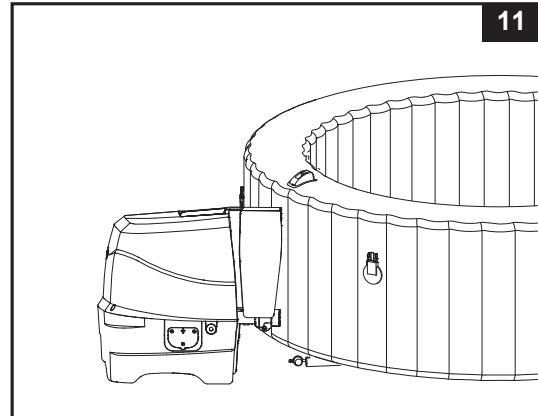
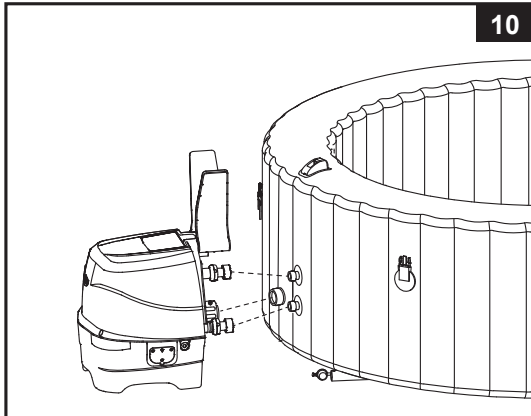



3. Attach the filter cartridge housing assembly to the inside of the spa tub outlet grid (lower position) (see drawing 12). Inflate the spa tub first before installing filter pump fittings.
4. Before filling with water ensure the bottom drain valve caps are securely closed on the inside and outside.
5. Fill the spa tub with freshwater to a level between MIN and MAX marked on the inside of the spa wall. Do not over fill the spa. Never move the spa tub with water inside and/or with the control base attached to the spa as the spa or control base may be damaged.

WARNING: Never pour water with a temperature higher than 40°C (104°F) into the spa directly. It is recommended to fill the spa tub with lukewarm water for quick heating and energy saving.

6. Place the spa cover and spa air bladder (pre-installed in spa cover) over the spa tub, and make sure the spa cover buckles are locked using the key provided after pulling the buckled straps tight.

IMPORTANT: Inspect the spa cover regularly for leak, premature wear and tear or deterioration. Never use a damaged spa cover.

7. Ensure that the spa base is plugged into a properly located and sized electrical outlet and press the  button to turn on the control panel. Press the  button on the control panel to activate the heater, see "Spa Control Panel" operation section.

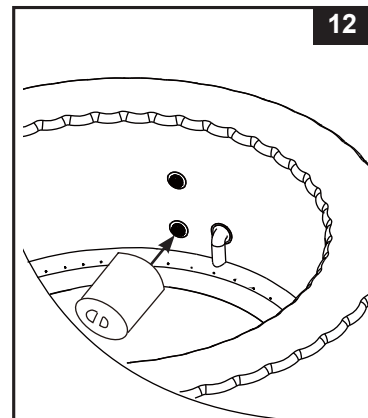

Spa Cover

The attachment buckles of the cover are locking buckles. Two keys are provided in the plastic bag with the manual and other accessories. Each buckle is marked with "locked" and "unlocked" symbols for easy operation: put the key into the slot on the buckle and turn it to the appropriate position to lock or unlock the buckle respectively.

To assure safety from unauthorized access, always put the cover on when spa is not in use and lock all buckles. Always keep the keys out of reach of children. In case you misplace the keys, you can use any similar size flat screwdriver to lock or unlock the buckles.

When the spa is being used, the cover should be placed in a clean, dry area, otherwise it can pick up dirt and bacteria. Covers should not be put on wooden tables or wooden decking because of the risk of bleaching the wood. A cover lifter, dedicated support or similar device, is recommended for ensuring that the cover, mostly its side facing the water, does not come into contact with the ground or any other dirty surfaces.

OPERATION

SPA CONTROL PANEL

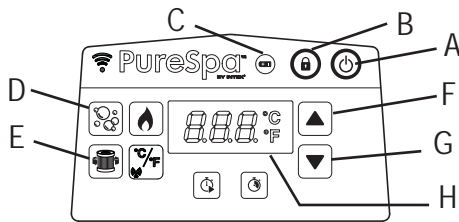

- A: On/Off Button
 B: Lock/Unlock Button
 C: Control Panel Battery Indicator
 D: Bubble Button
 E: Water Filter Button
 F: Increase Button
 G: Decrease Button
 H: LED Display



On/Off Button: Once the unit is plugged in, press this button to activate the control panel buttons. Press this button again to turn off all currently activated functions.



Lock/Unlock Button: Press and hold this button 3 seconds to lock/unlock the control buttons. If you forget to lock the keypad controls, the system will automatically lock it after 30 minutes of inactivity. The icon on the display is red when locked.



Control Panel Battery Indicator: The battery indicator will turn green when it is fully charged; turn red when it requires charging and flashing red when it is in charging mode.





Bubble Button: Use this button to activate the massage system, which has a 30-minute auto-shutoff feature. The bubble icon on the displays is green when activated.

CAUTION: Do not run Bubble system when the cover is attached, air can accumulate inside the spa and cause irreparable damage and bodily harm.



Water Filter Button: This button turns the filter pump on and off. The water filter icon on the display is green when activated and flashing 002H which is the minimum preset operating hours. Press again to increase the preset time from 002H, 004H to 006H. Pressing the button after the maximum number of hours (006H) will turn off the filter pump and the LED display shows the spa water temperature. If you have selected too many hours keep pressing to repeat the cycle. Once the operating time is set, the LED display will stop flashing after 10 seconds and the filter pump starts working. The cycle repeats itself at the same time each day for the number hours selected.

If the heating system is activated it will override the filter pump preset time function.

To view the preset time while the filter pump is operating, press  button, the display will briefly flash the preset hours for 10 seconds and then display back the remaining operating hours. To adjust the preset time, press  button twice until the display is flashing and repeat previous steps.

NOTE: The built-in hard water treatment function works automatically in conjunction with the filtration system.



Adjustment Buttons: Press the increase or decrease buttons to adjust the desired function settings. Press and hold the button will rapidly increase or decrease the numbers.

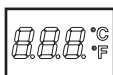

LED Display: Once plugged in the LED displays the current water temperature automatically. If the control panel (5) is activated and away from the control base charging dock, the LED display will go blank after 5 minutes. Press any button to resume the control panel.

Always check the control panel battery indicator. Recharge the control panel after each use.

⚠ WARNING

NEVER use the spa if indicated water temperature is more than 40°C (104°F).

OPERATION (continued)

SPA CONTROL PANEL

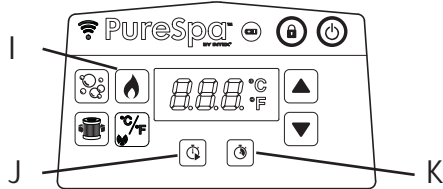

- I: Heat Button
 J: Heater Start Timer (HST) Button
 K: Heater Duration Timer (HDT) Button



Heat Button: Press this button to activate the heating system. Press ▲ or ▼ to set the desired water temperature. The heater will continuously heat until the water temperature reaches the set temperature and then hold at that temperature. This is achieved by the heater restarting automatically whenever the water temperature drops 1-2°C (1.8-3.6°F) below the set temperature. When the flame icon on the display is red, the heating system is activated. When the flame icon turns green, the water is at the set temperature. The heating system is then at rest, but the filtration system will continue circulating water nonstop, unless manually turned off. If the heating system is reactivated, the filter pump will restart at the same time.

NOTE: To stop the filtration system while the heater is at rest mode, press the flame button first and then the filter button. Pressing the heat button only while the heater is at rest mode will turn off the heating system only and the filtration system will operate for 1 more minute before it turns off or continue with the filter pump preset operating hours. To turn the heater off while heating, press the flame button.

IMPORTANT: The following conditions will lead to slow water heating.

- The ambient temperature is lower than 10°C (50°F),
- Outdoor wind speed is above 3.5-5.4 m/s (8-12 mph).
- The air bubble function is activated when heating the spa water.
- The spa is not properly covered with the spa cover when the water is heating.



Heater Start Timer (HST) Button: Use this button to select a future start time for the heating system. Press this button and then press ▲ or ▼ to set the number of hours by which you wish to delay the start of the heating system, from 000 to 120 hours. The icon will flash red for a few seconds and then stays red. The information shown on the LED display alternates between the remaining hours before heater start and the water temperature. Once the countdown timer reaches 000, the heating system will start operating. To deactivate the function at any time, simply set the HST time back to 000. To readjust the preset hours, press the HST button twice and adjust the hours with ▲ and ▼ buttons.

Example 1: It is 9:00pm Monday evening and you would like the spa to be hot on Friday evening.

Allowing for 24 hours for the spa to heat up (4 persons model about 1.5-2.5°C (3-4.5°F) per hour) the heater should be set to start on Thursday evening. With the Spa turned on, first press the Heat button and set your desired temperature. Press the HST button and then ▲ or ▼ until 072 hours is shown. The heater will start after 72 hours has passed (Thursday at 9:00pm) and will run until the desired temperature is attained. The heater will then cycle on and off to maintain the set temperature until turned off. To turn off the heater, press the flame button.



Heater Duration Timer (HDT) Button: Use this button to select the desired length of time the heating system should operate. Press this button and then press ▲ or ▼ to set the number of hours you wish the heater to operate before it automatically turns off, from 000 to 048 hours. The icon will flash red for a few seconds and then stays red. The heating system will operate for the amount of preset hours only. The timer takes priority over temperature, so the heater will shut off when HDT time runs out regardless if the preset spa water temperature is reached or not. During the HDT function, the information shown on the LED display alternates between the remaining heater operating hours and the water temperature. Repeat previous steps to reprogram this function. To deactivate the function at any time, simply set the HDT time back to 000. To readjust the preset hours, press the HDT button twice and adjust the hours with ▲ and ▼ buttons.

Example 2: Using the same scenario as example 1 above but rather than manually turning the heater off when you are finished, you would like the heater to turn off automatically on Saturday evening at 9:00pm. After going through the steps in example 1, press the HDT button and then the ▲ or ▼ button to select 048 hours. The heater will then run from Thursday at 9:00pm to Saturday at 9:00pm.

NOTE: If HST and HDT timers are both set, the LED display will first alternate between remaining time before the heater start and the water temperature, until HST timer runs out and the heater activates. Then the LED display alternates between remaining HDT time and water temperature until the HDT timer runs out as well.

OPERATION (continued)

SPA CONTROL PANEL

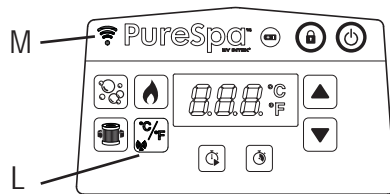

L: Celsius/Fahrenheit Toggle and Pairing Button

M: WiFi LED Indicator



Celsius/Fahrenheit Toggle Button: The temperature can be displayed in either Fahrenheit or Celsius. The system's default is Celsius.

NOTE: The default temperature is 20°C (68°F). Temperature adjustment ranges from 10°C (50°F) to 40°C (104°F). To change temperature unit on your mobile device App screen, touch the current temperature number shown on the App screen to switch between (°C / °F).



Pairing Button: Touch this button for 5 seconds to begin spa pairing with your mobile device.



WiFi LED Indicator Status:

- **ON/Solid:** The product is paired up and connected to the home WiFi signal successfully.
- **Flashing:** Pairing mode stage.
- **OFF/Blank:** Disconnected or not connected to the home WiFi signal. Touch the pairing button for about 5 seconds to repeat the pairing process. If the problem still persists, check the "Troubleshooting" section for more details.

OPERATION (continued)

IntexLink App Setup User Guide

The IntexLink App allows you to turn on/off any function on your spa, and program a schedule for future use remotely even when not at home from your mobile device.





WiFi APP
QR Code

System and WiFi Router Requirement

The Spa control base hardware communicates via Bluetooth and 2.4GHz WiFi network supporting 802.11b/g/n wireless technology. The hardware **does not support 5GHz WiFi** networks. It is recommended that you turn off your 5GHz WiFi network during the App setup and pairing process.

WiFi Pairing





For a successful first time WiFi pairing between the spa wireless control panel and your mobile device, make sure:

- To turn on the “**Bluetooth**” function on your mobile device and allow “**Nearby Devices**” permission (IntexLink App info → App permissions → Nearby devices → Allow).
- To turn on “**Location access**” on your mobile device.
- To keep the wireless control panel on the spa control base charging dock.
- The area where the spa will be installed is within your WiFi router coverage range. The area shall be free from metallic walls/mesh and other objects that may interfere with or reduce the WiFi signal.
- Turn off the mobile data (2G, 3G, 4G and LTE) function on your mobile device first, and make sure your mobile device is connected to your WiFi router before pairing the device with the spa control panel. Check the WiFi signal strength is full by browsing the internet with your mobile device using the connected WiFi network and ensure the webpage loading speed is fast.
- Follow below step-by-step sequence.
 - 1) Scan the WiFi App QR code located on the control base rating label or on this manual to install the App. You may also download the “IntexLink App” from your App store.
 - 2) Touch the  power button on the spa control panel to turn on the spa and make sure the spa control base is powered on.
 - 3) Open the App, create a new account (for first time user) and login into the App.
 - 4) Touch the  pairing button on the spa control panel for 5 seconds until a “beep” sound is heard. The WiFi LED indicator will flash to begin pairing with your mobile device.
 - 5) Touch the “**Add Device**” or “” button on the App to search for nearby devices.
 - 6) Touch the Spa icon to be added or paired up with.
 - 7) Choose your wireless router and enter the WiFi router password, then touch “**Next**” to begin pairing.
 - 8) Once the Spa is added successfully, the pairing is completed. Touch the “**Done**” button to begin using the IntexLink App.

How to share your product / device:

Open the App, touch the “Spa” icon, touch the setting () icon on the top right corner and then touch “Share Device”.

OPERATION (continued)













Heater Function Setting Examples			
 Temp set at (°C/F)	 HST	 HDT	Action
40/104	000H	000H	HST & HDT functions are off. Heating system has to be activated manually by pressing () button. See "Spa Control Panel" section for details. The heater will continuously heat until the temperature is reached and then hold at that temperature.
40/104	000H	005H	Turn the heater on and set a run time at which point the heater will turn itself off. The heater will continuously heat until the temperature is reached and then hold at that temperature until the 5 hours run time has expired, regardless if the water temperature has reached 40°C/104°F or not.
40/104	012H	005H	Turn the heater on some time into the future to a set temperature and set a run time at which point the heater will turn itself off. The heater will start after 12 hours and continuously heat until the temperature is reached and then hold at that temperature until the 5 hours run time has expired, regardless if the water temperature has reached 40°C/104°F or not.
40/104	012H	000H	Turn the heater on some time (in hours) into the future to a set temperature. The heating system will start after 12 hours, and continuously heat until the water reaches 40°C/104°F and then hold at that temperature. When the spa water temperature drops 1-2°C (1.8-3.6°F) below the set temperature the heating system will restart. When the flame icon on the display is red, the heating system is activated. When the flame icon turns green, the water is at the set temperature. The heating system is at rest and the filtration system will continue working nonstop.

Freeze Protection: the spa heater is programed to automatically heat the water if the water temperature falls below 4°C (39°F). While the spa should be stored during the winter months, the system will protect the internal components in the event of occasional freezing temperatures. The spa must be plugged in and the GFCI reset. The system will engage the filter pump along with the heater and will operate both until the water reaches 10°C (50°F).

If extended freezing weather is expected, please disassemble the spa and store it during winter according to the storage instructions.

Once the self-heating program is triggered, it cannot be switched off on the control panel until the water temperature has reached at least 5°C (41°F), unless it is unplugged.

OPERATION (continued)

Function	ON	OFF	Information shown on LED display alternates between
	✓		Remaining filter pump time and water temperature
		✓	
		✓	
	✓	✓	Remaining HST time and water temperature
	✓		
		✓	
	✓	✓	Remaining HST time and water temperature first. Then remaining HDT time and water temperature.
	✓		
	✓		
	✓	✓	Remaining HDT time and water temperature
		✓	
	✓		



NOTE: Keep the spa control panel within 5m (16ft) range of the control base to ensure good wireless transmission signal.

The spa control panel is resistant to water, but it is not designed to be completely submerged. Do not put the control panel in the water. Submersion could cause water to enter the panel causing damage to the electronics.

MINIMIZE HEAT LOSS AND ENERGY CONSUMPTION ADVICE

- 1) Always keep the spa cover on to minimize heat loss during heating of the spa between uses (but not while it is being used). Ensure the cover is fitted tightly, as per manufacturer's instructions to maximize insulation. It shall be recommended that the cover, when not in use, should be kept off the ground to retain its cleanliness (particularly the surface in close proximity to the water spa water surface). The cover should be stored in an appropriate location, where it cannot be damaged, or cause damage.
- 2) Check the set water temperature and consider lowering it for the times when the spa will typically not be in use.
- 3) Depending on external conditions, consider turning off the heater entirely if not using the spa for an extended period of time (where the spa provides this option, but still maintains residual disinfection/pH-values).
- 4) Consider that the comfortable temperature range during use may be lower than the maximum safe temperature.
- 5) Use the included insulating ground cloth underneath the spa to minimize heat loss through the bottom of the spa.
- 6) Maintain clean filters to preserve appropriate working conditions for the pump and avoid unnecessary water replacement and re-heating.

LED CODE CHART

LED Reading	CAUSE	SOLUTION
E81	Transmission signal failure	<ul style="list-style-type: none"> Reset the RCD, restart all over again. Place the control panel within 5 m (16 ft) of the control base unit. Press and hold POWER button for 5 seconds to turn off and charge the panel again. If problem persists, contact Intex Service Center.
E90	No water flow	<ul style="list-style-type: none"> Turn off and unplug the control unit. Ensure the outlet cover grid is clean and free from obstructions. Clean or replace the cartridge, see Maintenance and Storage section. Ensure the in/outlet connections on the spa tub and filter pump are not blocked. Keep the spa water properly sanitized to ensure a clean and unclogged filter cartridge. If problem persists, contact Intex Service Center.
E94	Water temperature too low	<ul style="list-style-type: none"> If the ambient temperature is below 0°C (32°F), we recommend not to use the spa. Turn off and unplug the control unit, add some warm water to raise the spa water temperature above 1°C (34°F), then press the  button to heat up the water to the desired temperature. If problem persists, contact Intex Service center.
E95	Water temperature too high	<ul style="list-style-type: none"> Turn off and unplug the control unit. When the water has cooled down, plug the RCD and restart all over again. Turn the heater off, then press the filter and bubble buttons to lower the water temperature. If problem persists, contact Intex Service Center.
E96	System Error	<ul style="list-style-type: none"> Turn off and unplug the control unit. Plug the RCD and restart all over again. If problem persists, contact Intex Service Center.
E97	Dry-fire Protection	<ul style="list-style-type: none"> Contact Intex Service Center.
E99	Water temperature sensor broken	<ul style="list-style-type: none"> Contact Intex Service Center.
END	After 72 hours of continuous heating operation, the pump will hibernate automatically. The rapid heating function is disabled.	<ul style="list-style-type: none"> Press the  button to re-activate the filter pump.
BLANK	Control panel battery has no power or in "Power Saving Mode" waiting to be placed on the control base charging dock.	<ul style="list-style-type: none"> Press any button to reactivate the control panel. Reset the RCD, restart all over again and charge the control panel again. Make sure the surface between the back of the control panel and the control base charging dock is clean, dry and free of obstruction. If problem persists, contact Intex Service Center.

MAINTENANCE AND CHEMICALS

⚠ WARNING

Always unplug this product from the electrical outlet before removing, cleaning, servicing or making any adjustment to the product.

Water Sanitation

The spa owner must regularly check and keep the spa water sanitized with scheduled maintenance (daily, if necessary). Adding sanitizer and other chemical will control bacteria and viruses present in the spa water. The maintenance of a proper water balance through appropriate use of sanitizers is the single most important factor in maximizing the life and appearance of the spa tub as well as ensuring clean, healthy and safe water. Proper technique is important for water testing and treating the spa water. See your pool/spa professional for chemical, sanitizer, test kits and testing procedures questions.

CAUTION: ALWAYS FOLLOW THE CHEMICAL MANUFACTURER'S DIRECTIONS, AND THE HEALTH AND HAZARD WARNINGS.

Do not add chemicals if the spa is occupied. This can cause skin or eye irritation. Concentrated chlorine solutions can damage the spa tub. In no event is Intex Recreation Corp., Intex Development Co. Ltd., their related companies, authorized agents and service centers, retailers or employees liable to the buyer or any other party for costs associated with the loss of spa water, chemicals or water damage.

Maintenance of Spa Water and Cartridge

Protect all the spa occupants from possible water-related illnesses by keeping the spa water clean and sanitized. Always practice good hygiene. To ensure proper spa water quality follow these procedures:

- Inspect and clean the filter cartridge every day, and change the filter cartridge every 3 days.
 - Unscrew the cartridge housing assembly from the spa tub wall and remove the cartridge (**see drawing 13**).
 - Use a garden hose to rinse off the cartridge. If the cartridge remains soiled and discolored it should be replaced. Keep spare cartridges on hand.
 - Reinstall the clean cartridge back into the cartridge housing and replace the cartridge housing assembly back onto the spa tub wall.
- Change the spa water every 2 weeks. See "Spa Tub Drainage" and "Spa Tub Cleaning" sections for details.
- Use spa chemicals to maintain proper water chemistry. Spa damage resulting from misuse of chemicals and mismanagement of spa water is not covered by the warranty.
- All occupants must shower before entering the spa.

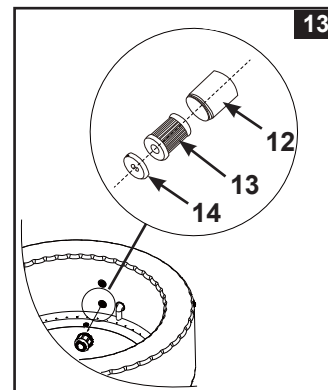

Water Chemistry Balance

Maintain the spa water pH level between 6.8 and 7.6, total alkalinity level between 60 and 120 ppm and free chlorine level between 2 to 4 ppm. Use the included test strips to test the spa water chemistry before each use of the spa and continue to test the water no less than once a week.

The Test Strips can test the "Free Chlorine", "pH", "Total Alkalinity" and "Calcium Hardness" levels at the same time:

- Dip the entire strip into the water and remove immediately.
- Hold the strip level for 15 seconds. Do not shake excess water from the strip.
- Compare the strip pad to the color chart on the packaging label. If necessary, adjust the chemical level in the pool water.

NOTE: Check the expiry date of the test kit as the test results may be inaccurate if the kit is used after that date. Low pH will damage the spa tub and pump. Damage resulting from chemical imbalance is not covered by the warranty.

Use the included chemical floater dispenser to administer chlorine [chemical tablet size: less than 1" (2.5 cm) diameter] into the spa water. Add 1 tablet into the dispenser. Always follow the chemical manufacturer's directions. Remove the chemical floater dispenser when the spa is in use.

Never let chlorine come in contact with the spa tub if it is not completely dissolved.

Flush all pipes with treated water by activating the bubble function for an hour a day.

IMPORTANT: Press the  button on the spa control panel to turn on the bubble air blower and help dissolve the chemicals into the water.

Never mix chemicals together. Add the chemicals to the spa water separately. Thoroughly dissolve each chemical before adding another one to the water.

SPA WATER CHEMISTRY AND BALANCE

Parameter	Value ^a
Water clarity	clear view of the bottom
Total Alkalinity (TA) in mg/l	60 to 120
Calcium Hardness (CaCO ₃) in mg/l	150 to 250
Colour of the water	no colour should be observed ^{b, c}
Turbidity in FNU/NTU	max. 1.5 (preferably less than 0.5)
Nitrate concentration above that of fill water in mg/l	max. difference of 20 compared to the fill water concentration
Total organic carbon (TOC) in mg/l ^d	max. 4.0
Redox potential against Ag/AgCl 3.5 M KCl in mV	min. 650
pH value ^{e, f}	6.8 to 7.6
Free active chlorine (without cyanuric acid) in mg/l	0.3 to 1.5 ^g
Bromine in mg/l	2.0 to 4.0 ^h

When using alternative/additional disinfectants other appropriate parameters may be considered.

- a Consult national regulations and guidelines for any deviations.
- b Natural water sources may introduce water colouration.
- c Intentional water colouration is excluded.
- d When using organic compounds this value may be higher.
- e Subject to the flocculant(s) used (if any).
- f When pH is greater than 7.5 the free active chlorine is less than 50 %.
- g Commonly recommended concentration of free chlorine in aquatic settings is 0.3 to 1.5 mg/l. However, in order to ensure water hygiene in the spa setting where the water is heated and the water volume to user ratio is low, it is acceptable to temporarily exceed this concentration with manual dosage, provided the health of the user is not compromised. Therefore, a range of 2.0 to 4.0 mg/l is acceptable as also recommended by the U.S. Environmental Protection Agency and the Center for Disease Control. Do not use cyanuric acid.
- h Temporary exceeding due to manual dosage and low water volume to user ratio is acceptable, provided the health of the user is not compromised.

Particular care should be taken with chemical treatment of the water with special attention to disinfectant limits and control of pH values. The use of ozone or UV, where applicable, shall always be accompanied by residual disinfection with an oxidising biocide (e.g. Chlorine or Bromine or other biocide products, compatible with manufacturer's recommendations).

Improper use of chemicals may result in degradation, damage and other imperfections of the spa surface and other spa components (typically discolouration of materials, corrosion of metal parts).

Free chlorine: is the chlorine residual present in the spa water.

Result if too low – Inadequate level of disinfection.

Result if too high – cause odor problem, skin & eye irritation, corroded metals and other materials.

pH: a value that indicates how acidic or basic the spa water is.

Result if too low – Corroded metals, eye & skin irritation, and destruction of total alkalinity.

Result if too high – Scale formation, cloudy water, shorter filter/heater runs, eye & skin irritation, poor chlorine efficiency.

Total Alkalinity (TA): indicates the degree of the water's resistance to pH change. It determines the speed and ease of pH change, so always adjust total alkalinity before adjusting the pH level.

Result if too low – Corroded metals, eye & skin irritation. Low alkalinity will cause the pH to be unstable.

Result if too high – Scale formation, cloudy water, shorter filter/heater runs, eye & skin irritation, high chlorine demand.

SPA WATER CHEMISTRY AND BALANCE (continued)

Calcium Hardness (CaCO₃): refers to the amount of calcium and magnesium dissolved in the water. Result if too low – Difficulty balancing water, corrosion of metal components, eye & skin irritation and water foaming. Result if too high – Scale formation, cloudy water, eye & skin irritation, difficulty balancing water and filter/heater inefficiency.

Saturation Index (SI): temperature, calcium hardness concentration, total alkalinity and pH represent the main factors influencing scale formation. The tendency of water to either form scale or corrode is indicated by the Saturation Index (SI):

$$SI = pH + TF + CF + AF - 12.1$$

*Where: TF = Temperature Factor; CF = Calcium Hardness Factor; AF = Total Alkalinity Factor

Water Temperature		TF	Calcium Hardness (ppm)	CF	Total Alkalinity (ppm)	AF
(°C)	(°F)					
8	46	0.2	75	1.5	50	1.7
12	54	0.3	100	1.6	75	1.9
16	61	0.4	150	1.8	100	2.0
19	66	0.5	200	1.9	150	2.2
24	75	0.6	250	2.0	200	2.3
29	84	0.7	300	2.1	300	2.5
34	93	0.8	400	2.2	400	2.6
40	104	0.9	500	2.3	--	--

Test the water pH, Temperature, Calcium Hardness and Total Alkalinity levels. Use the equivalent Factors in the SI equation.

SI = 0, Balance

If SI > 0, Scaling or cloudy water condition.

If SI < 0, Corrosive to metals or eye & skin irritating condition.

The SI is considered satisfactory if the value is within -0.3 to +0.3 range. Zero being perfect.

SPA Water Adjustment

How to adjust the spa water chemistry when the levels are off the range.

CAUTION: Always follow the chemical manufacturer's directions, and the health and hazard warnings.

Total Alkalinity (TA) Adjustment

Remove the spa cover to aerate the water and use the included test strips to check the chemistry level.

Ensure the chlorine level in the water is between 2-4 ppm first, as chlorine will affect the TA test result.

If the TA level (and not the pH) is higher than 120 ppm, add appropriate chemical product to lower the TA level.

If the TA level is lower than 60 ppm, add appropriate chemical product to raise the TA level.

NOTE: After adjustment, retest the water after 24 hours and adjust again if necessary.

pH Adjustment

After the total alkalinity has been lowered to 120 ppm or raised to 80 ppm and the pH is still high or low, add appropriate chemical product to adjust the pH level between 6.8 and 7.6.

Calcium Hardness Adjustment

Use the included test strips to check the water hardness level and adjust it with appropriate chemical product.

WARNING

Handle all chemicals with care and wear extra personnel protective equipment including goggle and gloves. It is very important not to splash acid onto your skin or clothing, or into your eyes.

MAINTENANCE

Spa Tub Drainage

1. Turn off the spa control unit.
2. Connect the drain valve adaptor to a garden hose and point the other end of the garden hose to a suitable draining area.
3. Remove the drain valve cap from outside of the spa tub and attach the drain valve adaptor to the drain valve (**see drawing 14**).
4. From inside of the spa tub, open the drain valve cap, water will start flowing out from the garden hose.
5. When the water stops draining, disconnect the spa control unit from the spa tub wall. Lift the spa tub wall from the side opposite the drain, leading any remaining water to the drain and emptying the spa completely (**see drawing 15**).
6. Attached the inflation hose (**7**) to the air blower inflation outlet on the control unit.
7. Turn on the spa and press the  button, aim the inflation hose at the inlet/outlets on the spa tub and spa control unit to dry out any water in the piping system (**see drawings 16 & 17**).
8. Use a clean towel to wipe up any remaining water and moisture on the spa tub and spa control unit.
9. Ensure the spa tub and spa control unit are thoroughly dried.
NOTE: The enclosed plugs (**15**) can be used to cover the water inlet and outlet connectors from the inside of the spa tub to prevent water from flowing out.

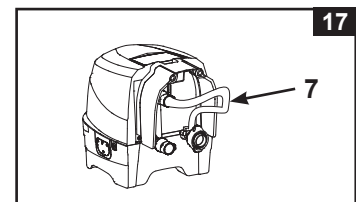
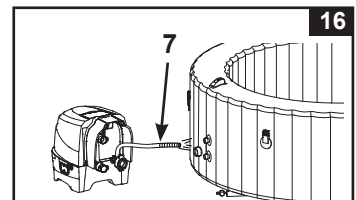
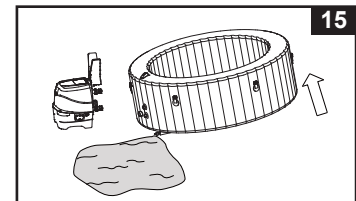
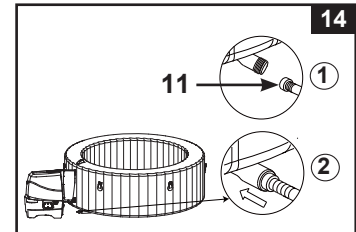

Spa Tub Cleaning

If dirt is visible in the water or water becomes cloudy and proper water chemistry does not clear it up, change the water and clean the spa tub. See "Spa Tub Drainage" section on how to drain the spa.

While empty, remove the cartridge housing from inside of the spa tub wall, clean and/or replace the filter cartridge. Use a sponge and mild soap solution to wipe away any soil or stains on the inside of the spa wall. Rinse thoroughly before refilling with clean water.

IMPORTANT: Do not use steel wool, hard brushes or abrasive cleaners.

Biofilm Removal

See your local spa professional for biofilm removal products and advice.

Spa Tub Air Valve Fastening

Check the spa tub air valve for leakage and tightness before use. If air is leaking from the air valve, use the provided wrench (**22**) to tighten the air valve as follow:

1. Make sure the spa tub is deflated, open the air valve cap and insert the wrench (**22**) into the air valve body (**see drawing 18**).
2. With one hand, hold the backside of the air valve base from the inside of the spa tub wall and turn the wrench (**22**) clockwise.

IMPORTANT: Never adjust the air valve base when the spa is in use or filled with water. Only use the air valve wrench if the air valve is loose or there is leakage around air valve base. Do not over tighten the air valve: over tightening can damage the valve. Just ensure the air valve is snug and not leaking.

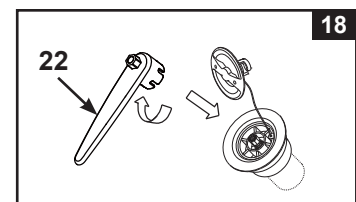

Spa Cover

Inspect the spa cover regularly for leaks, premature wear and tear, damage, or signs of deterioration. Never use a worn or damaged cover: it will not provide the level of protection required to prevent unsupervised access to the spa by a child.

Clean the cover inside and outside periodically using a sponge and a suitable solution that includes adequate disinfection (10 mg per liter of free chlorine). Do not use steel wool, hard brushes or abrasive cleaners.

MAINTENANCE (continued)

Spa Surround

Barefoot areas and relaxing areas around the spa shall be cleaned on a regular basis. No cleaning water may flow into the spa or spa water cycle. The dirt and cleaning agents shall be rinsed carefully to drain in the spa surround.

Spa Tub and Cover Air Bladder Repair

Use the enclosed repair patch to repair any puncture:

- Clean and dry the area to be repaired thoroughly.
- Remove the patch backing paper and press patch firmly over the puncture. Smooth out the surface to remove any air bubbles under the patch.

STORAGE

In regions subject to freezing temperatures, drain, clean, disassemble and properly store the spa set and related components indoors when the temperature drops below 4°C (39°F).

1. Drain and clean the spa following the "Spa Tub Drainage" and "Spa Tub Cleaning" sections.
2. Reverse set up instructions to deflate and disassemble the spa tub, spa control unit and spa cover air bladder.
3. To deflate the tub and the cover air bladder:
 - a) Open the deflation outlet cap (27) with the included wrench (22) (see drawing 19).
 - b) Insert deflation hose adaptor (28) into the deflation outlet.
 - c) Insert inflation hose (7) over the deflation hose adaptor (28).
 - d) Insert the other end of the inflation hose into the tub air valve or cover air bladder valve.
 - e) Press the air bubble  button to deflate.
 - f) When deflation is completed reverse above steps and ensures the deflation outlet cap (27) is securely fastened.

Caution: Only use for the purpose described in this manual.

Keep the inflation hose away from water or small objects when the deflation function is activated to avoid damage to the blower motor.

4. Make sure all the spa components and accessories are thoroughly clean and dry before storage. Air-dry the spa tub in the sun for an hour before folding.
5. Fold the spa tub loosely and avoid any sharp corners to prevent damage or leakage to the spa tub liner.
6. Prepare additional new cartridges for next time use.
7. Store the spa tub and accessories indoors, in a dry, temperature controlled, between 0° – 40°C (32° – 104°F), storage location.
8. The original packing can be used for storage.

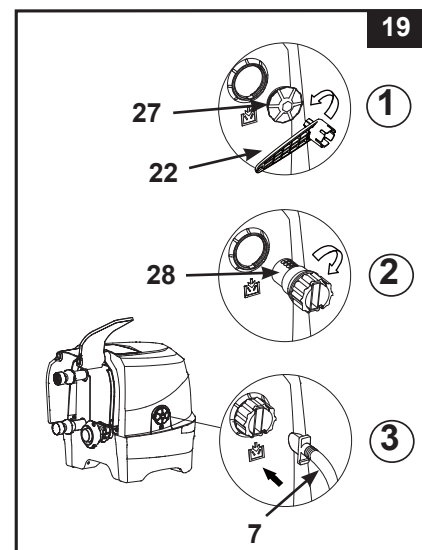

TROUBLESHOOTING

PROBLEM	CAUSE	SOLUTION
NO DISPLAY/SPA CONTROL UNIT DOES NOT WORK	<ul style="list-style-type: none"> Spa is unplugged or off. Control panel cable plug loose. Power failure. RCD tripped. RCD broken. 	<ul style="list-style-type: none"> Ensure the spa is plugged and switched on. Ensure the control panel cable plug is firmly attached to the control base receptacle. Check power source. Reset the RCD. Contact Intex Service Center.
HOUSEHOLD CIRCUIT BREAKER TRIPPED	<ul style="list-style-type: none"> Circuit breaker under rated. Overloaded circuit breaker. An electrical fault in the line. 	<ul style="list-style-type: none"> Ensure correct circuit breaker rating. Provide a dedicated circuit breaker feeding the spa electrical outlet only. Contact a qualified electrician to correct the electrical fault.
NOT HEATING PROPERLY	<ul style="list-style-type: none"> Temperature set too low. Dirty filter cartridge. Water temperature decreasing during heater STANDBY mode. Heating element failed. 	<ul style="list-style-type: none"> Increase the temperature and attach the spa cover. Clean or replace the filter cartridge in time. If heater is in STANDBY mode, press the flame button twice to heat up the water to the set temperature. Contact Intex Service Center.
BUBBLE AIR BLOWER DOES NOT WORK	<ul style="list-style-type: none"> Air blower pump is too hot. 	<ul style="list-style-type: none"> Turn off and unplug the spa. Let it cool down and restart all over again. If problem persists, contact Intex Service Center.
FILTRATION PUMP NOT WORKING	<ul style="list-style-type: none"> Dirty filter cartridge. Filtration inlet and/or outlet clogged. Filter pump motor failed. 	<ul style="list-style-type: none"> Clean or replace the filter cartridge in time. Check and clean filtration inlet and outlet regularly. Contact Intex Service Center.
WATER NOT CLEAN	<ul style="list-style-type: none"> Cartridge assembly not properly attached. Insufficient filtering time. Dirty filter cartridge. Improper water maintenance. Filtration inlet and outlet clogged. 	<ul style="list-style-type: none"> Ensure the cartridge assembly is properly attached. Increase filtration time. Clean or replace the filter cartridge in time. Keep the spa water properly sanitized. Refer to the chemical manufacturer's instructions. Check and clean filtration inlet and outlet regularly.
PUMP CONNECTORS ARE NOT LEVEL WITH THE SPA CONNECTORS	<ul style="list-style-type: none"> One characteristic of PVC is that it changes shape, which is normal. 	<ul style="list-style-type: none"> Elevate the pump with wood or another type of insulated material to bring the pump's connectors level with the spa's connectors.
TUB HAS A STRANGE SHAPE	<ul style="list-style-type: none"> Expanded internal air pressure by strong sunshine. 	<ul style="list-style-type: none"> Do not expose the spa to direct sunlight for extended period of time. Check the air pressure and release air if necessary. During very hot weather, you must check to see whether it is necessary to release some air. This is to avoid any possible damage to the tub.

TROUBLESHOOTING (continued)

PROBLEM	CAUSE	SOLUTION
TUB LOSES AIR PRESSURE	<ul style="list-style-type: none"> • Air valve cap loose. • Air valve base loose. • Hole, cut or split on spa tub. 	<ul style="list-style-type: none"> • Ensure air valve cap is securely closed. • Fill up the spa tub with air then make sure the air valve base is tighten, see "Spa Tub Air Valve Fastening" section. • Put liquid soap and water in a squirt bottle and spray on seams. If there is a leak it will bubble. After you find the leak, clean and dry the leaking area, then apply the repair patch that comes with your spa.
LEAKING BETWEEN SPA TUB CONNECTORS AND CONTROL UNIT CONNECTORS	<ul style="list-style-type: none"> • Spa control base inlet/outlet connections not securely tight. • Spa control base inlet/outlet o-ring missing/dirty. 	<ul style="list-style-type: none"> • Tighten inlet and outlet connections. • Coat the o-ring with petroleum jelly for water proof. • Remove grid from inside spa with a screwdriver, ensure inlet/outlet O-ring is in place, clean and not damaged.
SPA IS TOO NOISY IN FILTRATION MODE ONLY	<ul style="list-style-type: none"> • Control base components not securely attached. • Control base ground not level and firm. • Spa filter motor failed. 	<ul style="list-style-type: none"> • Ensure control panel, back cover and all inlet/outlet are securely connected. • Ensure ground is level, firm and smooth. • Replace the failed filter motor with a new one.
AIR PRESSURE IS WEAK DURING INFLATION	<ul style="list-style-type: none"> • Hose adaptor o-ring missing. • Inflation hose adaptor not securely tighten. • Connection between the hose adaptor and blower inflation outlet, and between the inflation hose and inflation valve are loose. • Air blower failure. 	<ul style="list-style-type: none"> • Ensure the o-ring is in place. • Tighten/reinstall hose adaptor. • Finger tighten during inflation. • If problem persists, contact Intex Service Center.
AIR BUBBLES ARE NOT AS STRONG AS BEFORE	<ul style="list-style-type: none"> • O-ring missing between the control base air outlet and spa tub air inlet connections. • Air connection nut is not securely tight. • Air bubble channel passage inside the tub broken or leaking. • Air blower failure. 	<ul style="list-style-type: none"> • Ensure the o-ring is in place. • Finger tighten all nuts. • Use repair patch to repair any puncture. • If problem persists, contact Intex Service Center.

WIFI APP TROUBLESHOOTING

PROBLEM	CAUSE	SOLUTION
WIFI PAIRING FAILURE DURING THE FIRST TIME SETUP	<ul style="list-style-type: none"> Spa control base does not support WiFi App function, wrong model. Spa wireless control panel does not support WiFi App function. 	<ul style="list-style-type: none"> Only compatible with the Intex Spa Models showing "...WF.." characters in the model number as printed on the spa control base electrical rating label. Make sure the spa wireless control panel has the WiFi signal icon . Make sure the spa control base and wireless control panel are both compatible and support WiFi App function. Contact Intex Service Center.
	<ul style="list-style-type: none"> Wrong version of mobile device. 	<ul style="list-style-type: none"> Ensure the right version of mobile devices: <ol style="list-style-type: none"> iOS - Apple iPhone 6, 6 Plus and greater. Tablet compatibility is not optimized. Android – All Android phones. Tablet compatibility is not optimized.
	<ul style="list-style-type: none"> Incompatible mobile device operating system. 	<ul style="list-style-type: none"> Ensure the right version of operating system: <ol style="list-style-type: none"> Apple devices – iOS 11.0 and greater. Android devices – Android 6.0 and greater. For 6.0 and greater version, you must turn on the GPS signal on your mobile device for the first time pairing. Once you have successfully paired the spa and save it, you may turn off the GPS signal.
	<ul style="list-style-type: none"> Wrong router network band. 	<ul style="list-style-type: none"> Make sure you are connecting to a 2.4GHz network and try to pair the mobile device with the spa control panel again.
	<ul style="list-style-type: none"> Wrong network name. 	<ul style="list-style-type: none"> Make sure you are connecting to the right WiFi router signal and try to pair the mobile device with the spa control panel again. Make sure your mobile device and spa control panel are connected to the same WiFi router signal.
	<ul style="list-style-type: none"> Wrong WiFi password. 	<ul style="list-style-type: none"> Ensure correct WiFi router password. See WiFi pairing section.
	<ul style="list-style-type: none"> The setup spa location is too far from your WiFi router signal coverage range. 	<ul style="list-style-type: none"> Ensure your mobile device is connected to your WiFi router and can access and browse the internet. Remove the wireless control panel from the control base and bring it closer to your WiFi router while making sure it's within 5m (16ft) distance of the control base in order to prevent activating the error code E81 (transmission signal failure). Then try to pair the spa control panel with your mobile device. If it can be paired, your spa is too far away and you need to make sure the entire SPA is within your WiFi router signal coverage range. If you cannot move your spa, then you need to move your WiFi router or add a repeater/signal booster so that you can receive signals from your WiFi router at your setup spa location. Try to pair the mobile device with the spa control panel again.
	<ul style="list-style-type: none"> The App does not load. 	<ul style="list-style-type: none"> Force-quit the App, re-launch the App and try to pair the spa control panel with your mobile device again. Ensure the right version of mobile devices and operation system. Uninstall the App and reinstall it again. See WiFi pairing section.
	<ul style="list-style-type: none"> Bluetooth and WiFi not activated on your mobile device. IntexLink App "Nearby Devices" not activated. Your mobile device "Location access" is not activated. 	<ul style="list-style-type: none"> Turn on the Bluetooth and WiFi functions on your mobile device first. Allow "Nearby Devices" permission (IntexLink App info → App permissions → Nearby devices → Allow). Turn on "Location access" on your mobile device while using the App. Power off the spa control base and the wireless control panel, restart the spa and try to pair the spa control panel again. See "WiFi Pairing" section. If the problem persists, contact Intex Service Center.
	<ul style="list-style-type: none"> Wrong WiFi pairing sequence. 	<ul style="list-style-type: none"> Refer to "WiFi pairing" section.

WiFi APP TROUBLESHOOTING (continued)

PROBLEM	CAUSE	SOLUTION
OFFLINE AFTER SUCCESSFUL INITIAL SETUP AND PAIRING	<ul style="list-style-type: none"> LED display is off. E81. Control panel charging failed. Control Panel failure. 	<ul style="list-style-type: none"> Press any button to reactivate the spa control panel. Reset the GFCI/RCD, restart all over again and make sure the wireless control panel is fully charged. Make sure the surface between the back of the wireless control panel and the control base charging dock is clean, dry and free of obstruction. Try to pair the mobile device with the spa control panel again. If problem persists, contact Intex Service Center.
	<ul style="list-style-type: none"> WiFi signal failure. WiFi LED indicator light is blank. 	<ul style="list-style-type: none"> Reboot the WiFi router by powering it off for one minute and then turning it back on. Refer to your WiFi router's troubleshooting guide for more assistance. Make sure your mobile device and spa control panel are connected to the same WiFi router signal, and your mobile device can access and browse the internet from the location where the spa is setup. If you cannot move your spa, then you need to move your WiFi router or add a repeater/signal booster so that you can receive signals from your WiFi router at your setup spa location. Power off the spa control base and the wireless control panel, restart the spa and try to pair the spa control panel again. Try connecting using your mobile data function (2G, 3G, 4G and LTE), if it works, there may be a firewall that is preventing communications between your mobile device and the spa. If the problem persists, contact Intex Service Center.
	<ul style="list-style-type: none"> The App does not load. 	<ul style="list-style-type: none"> Force-quit the App, re-launch the App and try to pair the spa control panel with your mobile device again. Make sure your mobile device data function is activated and the device can access and browse the internet. If the mobile data function (2G, 3G, 4G and LTE) works, try pairing the spa control panel to your Wi-Fi router network. See WiFi pairing section.
	<ul style="list-style-type: none"> Other interferences. 	<ul style="list-style-type: none"> Make sure there are no big metallic walls, objects between the spa and your WiFi router signal. Make sure the surface between the back of the wireless control panel and the control base charging dock is clean, dry and free of obstruction. Always return the wireless control panel to the spa control base charging dock after using the spa or when the spa is not in use.

IMPORTANT

If you continue to experience difficulty, please contact our Consumer Service Department for assistance. See separate "Authorized Service Centers" sheet.

FILTER PUMP MOTOR DISASSEMBLY

If there is a need to replace the filter motor (for qualified technician only), follow below steps to disassemble it:

IMPORTANT: You must drain out any remaining water inside the piping system of the control base before replacing any parts.

Tools required: One adjustable wrench and one Philip screwdriver.

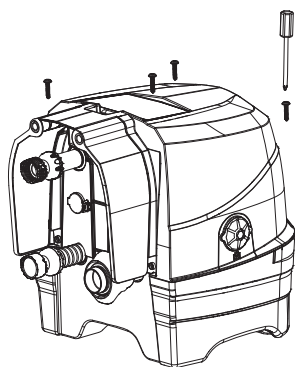

1

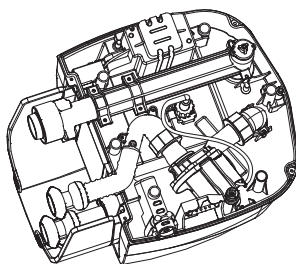

2

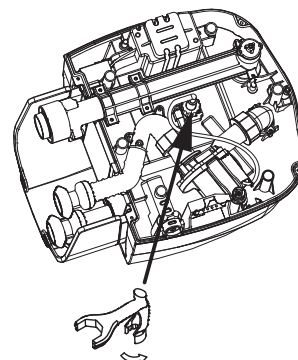

3

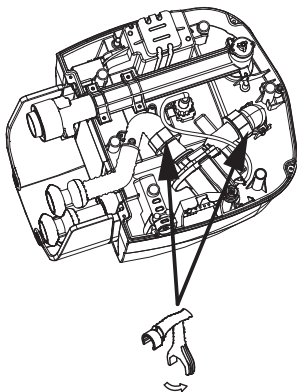

4

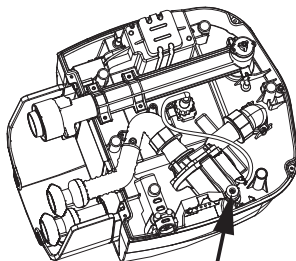

5

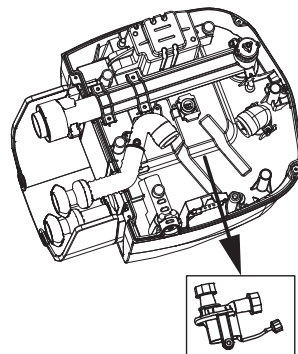

6

NOTE: The “special wrench tool” is included with the new filter pump motor replacement and not with the spa set.

WARRANTY

Your PureSpa has been manufactured using the highest quality materials and workmanship. All Intex products have been inspected and found free of defects prior to leaving the factory. This limited warranty applies only to the PureSpa only.

This limited warranty is in addition to, and not a substitute for, your legal rights and remedies. To the extent that this warranty is inconsistent with any of your legal rights, they take priority. For example, consumer laws across the European Union provide statutory warranty rights in addition to the coverage you receive from this limited warranty: for information on EU-wide consumer laws, please visit the European Consumer Center website at http://ec.europa.eu/consumers/ecc/contact_en/htm.

The provisions of this limited warranty apply only to the original purchaser and are not transferable. This limited warranty is valid for a period of one (1) year from the date of the initial retail purchase. Keep your original sales receipt with this document, as proof of purchase will be required and must accompany warranty claims or the limited warranty will be invalid.

PureSpa Warranty – 1 Year

If you find a manufacturing defect in the PureSpa during the warranty period, please contact the appropriate Intex Service Center listed in the separate "Authorized Service Centers" sheet. If the item is returned as directed by the Intex Service Center, the Service Center will inspect the item and determine the validity of the claim. If the item is covered by the provisions of the warranty, the item will be repaired or replaced, with the same or comparable item (at Intex's choice) at no charge to you.

Other than this warranty, and other legal rights in your country, no further warranties are implied. To the extent possibly in your country, in no event shall Intex be liable to you or any third party for direct or consequential damages arising out of the use of your PureSpa, or Intex or its agents' and employees' actions (including the manufacture of the product). If your country does not allow the exclusion or limitation of incidental or consequential damages, this limitation or exclusion does not apply to you.

You should note that this limited warranty does not apply in the following circumstances:

- If the PureSpa is subject to negligence, abnormal use or application, accident, improper operation, improper voltage or current contrary to operating instructions, improper maintenance or storage;
- If the PureSpa is subject to damage by circumstances beyond Intex's control, including but not limited to, ordinary wear and tear and damage caused by exposure to fire, flood, freezing, rain, or other external environmental forces;
- If the PureSpa is used for any commercial purposes;
- To parts and components not sold by Intex; and/or.
- To unauthorized alterations, repairs or disassembly to the PureSpa by anyone other than Intex Service Center personnel.

The costs associated with the loss of pool water, chemicals or water damage are not covered by this warranty. Injury or damage to any property or person is not covered by this warranty.

Read the owner's manual carefully and follow all instructions regarding proper operation and maintenance of your PureSpa. Always inspect your product prior to use. This limited warranty will be void if use instructions are not followed.